

Bucket Selection Guide

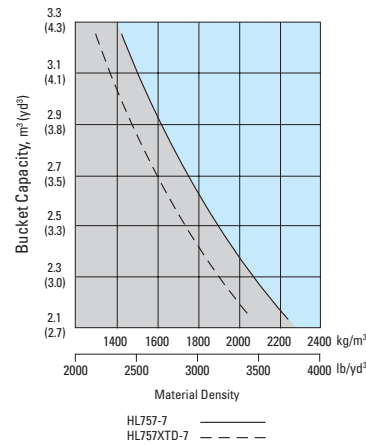

Supplemental Specifications

Description	Change in operating weight kg(lb)	Change in static tipping load-straight kg(lb)	Change in static tipping load-40° turn kg(lb)
17.5-25 12PR L3 tires	-248 (-547)	-184 (-406)	-163 (-359)
20.5-25 16PR L2 tires	-64 (-141)	-48 (-106)	-42 (-93)
20.5 R25 XHA ★	+507 (+1118)	+377 (+831)	+332 (+732)
20.5-25 16PR L5 tires	+596 (+1314)	+442 (+974)	+392 (+864)

Standard Equipment

- Electrical system**
- Alternator, 70A
 - Alarms, audible and visual
 - air filter clogging
 - transmission error
 - alternator voltage
 - brake oil pressure
 - engine oil pressure
 - parking brake
 - hydraulic oil temperature
 - coolant temperature
 - service brake oil pressure
 - Batteries, maintenance-free 950 CCA, 12V, (2)
 - Gauges
 - engine coolant temperature
 - fuel level
 - hydraulic oil temperature
 - speedometer
 - transmission oil temperature
 - voltmeter
 - Horn, electric
 - Indicator lights
 - clutch cut-off
 - high beam
 - turn signal
 - work light
 - LCD Display
 - clock and fault code
 - operating hour counter
 - engine rpm
 - transmission gear range indicator
 - job time and distance
 - temperature(coolant, hydraulic oil, t/m oil)
- Lighting system**
- 2 dome lights
 - 2 stop and tail lights
 - 4 turn signals
 - brake lights(counter weight)
 - license plate light
 - head light
 - 2 on front tower
 - working lights
 - 2 on front roof
 - 2 on grill
- Switches**
- buzzer stop
 - clutch cut-off
 - hazard
 - Ignition key, start/stop switch
 - main light(illumination and head light)
 - parking
 - rear wiper & washer
 - work light
 - full automatic transmission
- Starter, electric**
- Starting and charging system(24-volt)**
- Cab**
- Cab, ROPS/FOPS (sound suppressed and pressurized) with:

- cigar lighter & ashtray
 - coat hook
 - front/rear window defroster
 - intermittent wiper and washer, front and rear
 - personal storage space: console box, cool & hot box holder, can and cup
 - rear view mirrors (2 inside)
 - rear view mirrors (2 outside)
 - seat belt
 - seat, adjustable suspension with armrests
 - steering column, tilt and telescopic
 - steering wheel with knob
 - sunvisor(front window)
 - tinted safety glass
 - two door cab, fixed glass
 - Magazine box
 - Pedals
 - one accelerator pedal
 - one brake pedal
 - Rubber floor mat
 - Wrist rest
- Engine**
- Antifreeze
 - Engine, Cummins QSB5.9-C
 - Low Emission Diesel, Tier-II
 - Engine enclosure, lockable
 - Engine fuel priming pump

- Fan guard
 - Fuel/water separator
 - Muffler, under hood with large exhaust stack
 - Precleaner, engine air intake
 - Radiator
 - Starting aid (air intake heater)
 - Water sensor on fuel filter
- Power Train**
- Brakes : Service, enclosed wet-disc
 - Differentials, torque proportioning (front/rear)
 - Parking brake
 - Torque converter
 - Transmission, computer-controlled, electronic soft shift, auto-shift and quick-shift features included
 - Transmission oil cooler
- Hydraulics**
- Boom lock safety valve
 - Boom kickout, automatic
 - Bucket positioner, automatic
 - Diagnostic pressure taps
 - Hydraulic oil cooler
 - Hydraulic system,
 - 2 spool, single lever, pilot control for boom and bucket actuation
 - Steering, load-sensing
 - Remote cooling fan, hydraulically-driven,

- temperature sensing type
- Others**
- Articulation locking bar
 - Coolant level sight gauge
 - Counterweight
 - Door and cab locks, one key
 - Doors, service access(locking)
 - Drawbar with pin
 - Engine oil level dipstick gauge
 - Ergonomically located and slip resistant, left & right
 - handrails
 - ladders
 - platforms
 - steps
 - Fenders(front/rear)
 - Guard, bucket cylinder rod
 - Hydraulic oil level sight gauge
 - License plate bracket
 - Lift and tie-down hooks
 - Loader linkage, sealed Z-Bar design
 - Steering stops, cushioned
 - Tires(20.5-25, 16PR, L3)
 - Transmission oil level dipstick gauge
 - Vandalism protection caplocks

Optional Equipment

- 24-volt to 12-volt DC converter
- Air condition :
 - air conditioner
 - air conditioner with heater
 - heater
- Alarm, back-up
- Beacon light, rotating
- Cutting edge, bolt-on type
- Differential, limited slip(front/rear)
- Emergency steering system
- Fire extinguisher
- Fuel warmer
- High lift arrangement with additional counterweight, 280kg (617 lb)
- Hourmeter
- Hydraulic control, 2 lever
- Hydraulic control, 3 lever
- Hydraulic arrangement, 3-valve
- Lighting, auxiliary, 4 on roof
- Main disconnect switch
- Mud guard
- Open Canopy (ROPS/FOPS)
- Operator suit
- Radio cassette player
- Ride control system
- Seat
 - 2" static seat belt & adjustable mechanical suspension(vinyl)

- 3" static seat belt & adjustable mechanical suspension
- 3" retractable seat belt & adjustable air suspension
- Tires :
 - 17.5 - 25, 12PR, L3
 - 20.5 - 25, 16PR, L2
 - 20.5 R25 XHA ★
 - 20.5 - 25, 16PR, L5
- Tool kit
 - Tooth, 1 piece, bolt-on type
 - Tooth, 2 pieces, bolt-on type
 - Two brake pedal
- Guards
 - crankcase
 - transmission
- Wheel chock
- Window, sliding (left and right side)

Standard and optional equipment may vary. Consult your Hyundai dealer for more information. The machine shown may vary according to territorial specification.



HEAD OFFICE 1 CHEONHA - DONG, DONG-KU, ULSAN, KOREA
 (Sales Office) TEL : (82)(52)230 - 2114 FAX (82)(52)230 - 7979
 U.S. Operation 955 ESTES AVENUE ELK GROVE VILLAGE IL. 60007
 TEL : (1)847 - 437 - 3333 FAX : (1)847 - 437 - 3574
 European Operation VOSSENDAAL 11, 2440 GEEL, BELGIUM
 TEL : (32)14 - 562200 FAX : (32)14 - 593405 - 06

PLEASE CONTACT

www.hyundai-ce.com

2003. 10 rev1

HYUNDAI WHEEL LOADER

NEW 7 SERIES

HL757-7

- Cummins QSB5.9-C Engine
- Gross Power : 129 kW / 173 HP
- Max. Power : 140kW / 188HP
- Bucket Capacities : 2.3 to 2.7 m³ (3.0 to 3.5 yd³)
- Operating Weight : HL757-7 13,800 kg (30,420 lb)
HL757XTD-7 14,300 kg (31,530 lb)

Tier II Engine



■ Photo may include optional equipment.



Hardworking Hyundai Loaders

Meet the new generation wheel loader in Hyundai.

The HL757-7 will give you the satisfaction in higher power, lower fuel consumption, more comfort and lower emission .

Come and experience what Hyundai has created for you by bringing together power and technology.



Wheel Loader *HL757-7*

Engine

- Electronic Engine Control System
- Engine Protection & Selfdiagnosis System
- Max. Power 188 HP

Transmission

- 2 Automatic Selection Mode
- 2 Kick Down Function Mode
- AEB Function

Axle

- Pilot type Front Axle

■ Photo may include optional equipment.

Control Center

The all-new, deluxe operating space was engineered with 3-D modeling to be your ultimate control center. The wide, tinted and laminated front windshield has no framing cutting through to ensure excellent visibility.



Up-to-date-technology CAN system

Engine control Unit(ECU), Transmission control Unit(TCU) and Machine control Unit(MCU) realize the optimal performance through the mutual CAN communications.

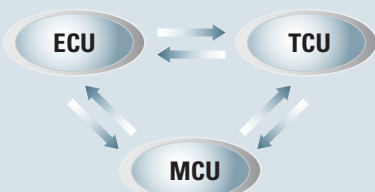

Adjustable steering column

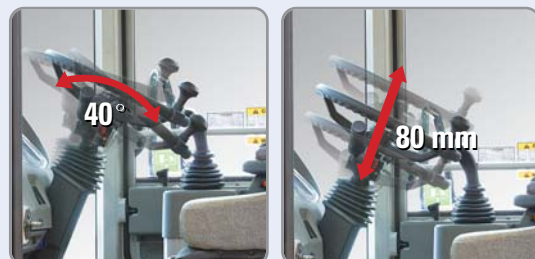

Full automatic shift lever

A single lever on the left side of the steering column gives the operator fast, easy control of speed and direction. Push the lever forward to go forward, pull it back for reverse. Travelling is automatically changed from 1st stage to given stage according to travel speed and tractive effort. The operator can select two kinds of automatic modes (1st ↔ 4th, 2nd ↔ 4th). This exclusive feature contributes to a step-up in productivity and reduction of operator's fatigue.

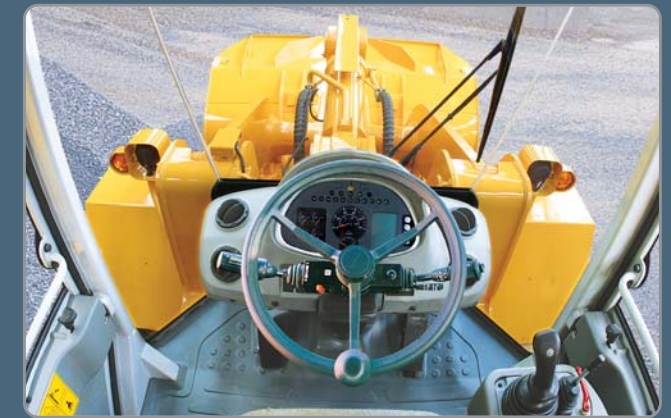

The Centralized Display & Attached Instrument Panel

The centralized digital display the status and conditions of your machine at a glance. Easy-to-read gauges and adjustable tilting and telescopic steering with an attached instrument panel provide constant, and accurate information.



Joystick Control Lever

Two kickdown switches located on top of the loader control lever and the gear shifting lever allow the operator to change instantly to 1st stage lower gear, in order to drive at full power into the material.



The Air Conditioning and Heating System



The operator can easily control the temperature and air flow. The defroster on the front windshield and rear window makes it convenient for winter working usage.



Ride control system (optional)

The ride control system is available for smooth travelling as option. It significantly reduces machine bouncing and absorbs the shocks in the machine, enhancing the productivity of the machine. This system reduces the fatigue of the driver as well as the stress on the structures and components. The system is consisted of accumulators in the hydraulic lift circuit, hydraulic control valve and selection switch.

① Off position : Function is cancelled ② On position : Function is available ③ Auto position : Function is available when the machine travels above 9.5km/hr(6.0mph). If the machine travels under 8 km/hr (5.0 mph), the function is cancelled automatically.

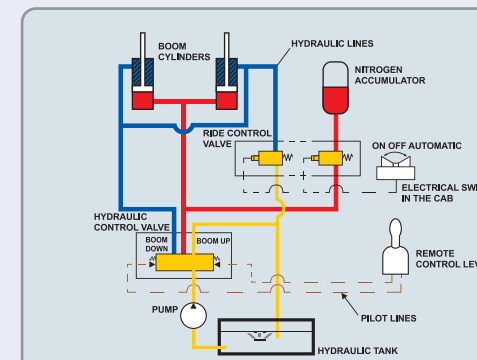

A Well Rounded System



Up-to-date hydraulic remote cooling fan

The minimum fuel consumption and low noise by applying hydraulic cooling fan sensing coolant temperature, intake air temperature, transmission oil temperature, and hydraulic oil temperature.



Engine

The CUMMINS QSB5.9-C electronic control engine combines full-authority electronic controls with the reliable performance. The combination of improved airflow and evenly dispersed fuel results in increased power, improved transient response and reduced fuel consumption.

And the QSB5.9-C used advanced electronics controls to meet the thoughts emission standards (EPA TierII, EU StageII)



Multi Function Transmission

The newly developed transmission control represents the beating heart of transmission. The hydraulic system for gearshifts is working with proportional valves, which allow a very precise control of the clutches. For each gearchange, the control unit performs a monitoring function to ensure the specified shift curve is adhered to, and readjusts the shift pressure applied to the clutches accordingly. This results in smooth gearshifts-even under load-with no traction interrupt. This helps to avoid standstill of the vehicle, sudden load changes and torque peaks under all conditions, for example application on steep terrain with full load. In addition, there is the option for the driver to make gearshifts manually.



Axle

Increased mounting strength by applying the fixed front axle pilot.

■ Photo may include optional equipment.



Left and right access door



Bucket cylinder guard

This guard helps to prevent possible damage from load material.

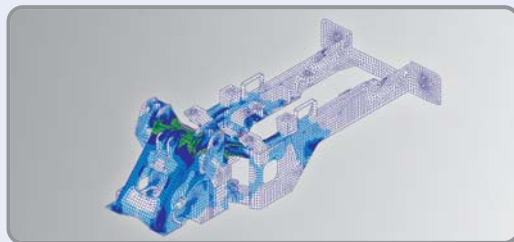

High-rigidity frames

Front and rear frames are designed for work in the toughest applications to provide high rigidity for the power train and loader equipment. The high-rigidity frames, together with the reinforced loader linkage, resist loading stress and shock.



Battery master switch

A master switch disconnects the battery power to protect the electrical system from excess electrical drainage.



Sealed loader linkage

Fully protected fitting is and the sealed loader linkage with dust seals and o-ring will extend lubrication intervals remarkably.



Frame lock

Machine can be locked by this locking bar to prevent movement during transportation.



Drive Shaft

Permanent lubricating drive shaft. There is no need to add grease periodically.

Accessible and Serviceable



■ Photo may include optional equipment.



Easy Access to All Engine Accessory

Here you find the engine oil check, and the main and pre-filters. The large access engine side panels permit easy and safe inspections. The fuel filter can be spun on and off for quick replacements.



Cabin Air Fresh Filter

The internal pressure is maintained to be slightly higher than that of outside to exclude dust and to reduce noise levels.



Fuse Box

A concentrated fuse box for easy inspection.



Coolant Sight Gauge

The coolant sight gauge is installed on the radiator top tank for convenient checks of coolant level.



Accessible grease fittings

Grease fittings are highlighted and available around the machine for fast access when doing your service checks.



Simple air filter replacements

The air cleaner is easily replaceable by turning the wing nut on the outer shell counter-clockwise.



Central electric controllers

Electric controllers for this Hyundai loader are centralized to improve serviceability.



Remote type drain port

It is now easier to change your engine oil, coolant and hydraulic oil with the remote drain port.



Hydraulic tank

The hydraulic tank is located behind the cab to increase the accessibility of hydraulic hoses and piping.

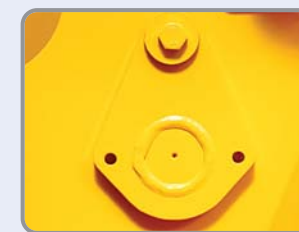

Open pin access

You can more readily remove or tighten your front attachment pin with these open connectors surrounding the pin.



Oil sight gauge

The hydraulic oil check sight gauge is installed on the side of the hydraulic tank for convenient checks from ground level.



Transmission oil port

The transmission oil change port is also located for open accessibility and comes with an anti-vandalism lock for your machine protection.



Specifications & Dimensions



Engine

Maker/Model	CUMMINS QSB5.9-C
Type	4-cycle, turbocharged, charge aircooled direct injection, electronic controlled diesel engine
Gross power	173HP(129 kW) / 2,200rpm
Net power	164HP(122 kW) / 2,200rpm
Maximum power	188HP(140 kW) / 1,900rpm
Maximum torque	82kg·m(590 lb-ft) / 1,500rpm
No. of cylinders	6
Bore x Stroke	102 mm (4.0") x 120 mm (4.7")
Displacement	5.9 ℓ (360 cu in)
Compression ratio	18.0 : 1
Air cleaner	Dry, dual elements
Alternator	24V, 70 Amp
Battery	2 x 12V, 160 Ah.
Starting motor	24V, 3.7 kW

Net power output of standard engine as installed in this vehicle(per SAE J1349) complete with fan, air cleaner, alternator, water pump, lubricating oil pump and fuel pump. No derating for continuous operating required up to 3048m (10000ft). This engine meets the EPA(Tier II) / EU(Stage II) Emission regulation.

Transmission

Full automatic power shift, countershaft type with soft-shift in range and direction. Properly matched torque converter to engine and transmission for excellent working ability

Torque converter type	3-elements, single-stage single-phase	
Stall torque ratio	2.873 :1	
Travel speed	20.5-25, L3 km/h (mph)	
Forward	1st	7.4(4.6)
	2nd	12.1(7.5)
	3rd	23.7(14.7)
	4th	37.0(23.0)
Reverse	1st	7.8(4.8)
	2nd	12.8(8.0)
	3rd	25.0(15.5)

Axles

Drive system	Four-wheel drive system
Mount	Rigid front axle and oscillating rear axle
Rear axle oscillation	±13° (total 26°)
Hub reduction	Planetary reduction at wheel end
Differential	Torque proportional differential
Reduction ratio	23.418

Hydraulic system

Type	Open-centered, tandem circuit system. Pilot-operated controls. Closed with pressure and vacuum relief.
Pump	Helical gear type, 220 liters/min (58.1 gal/min)@governed rpm
Control valve	Two function valve with single or two lever controls : Optional third-function valve with auxiliary lever.
Relief valve setting	210 kg/cm ² (2,990 psi)
Pilot system	
Type	Pilot oil pressure is generated by the pilot oil supply unit.
Relief valve setting	30 kg/cm ² (427 psi)
Bucket controls	
Type	Pilot operated lift and tilt circuit, single-lever(joystick) control standard.
Lift circuit	The valve has four functions ; raise, hold, lower and float. Can adjust automatic kickout from horizontal to full lift.
Tilt circuit	The valve has three functions ; tilt back, hold and dump. Can adjust automatic bucket positioner to desired load angle.
Cylinder	Type : Double acting No. of cylinders-bore x stroke; Lift 2-140 mm(5.5") x 750 mm(29.5") Tilt 1-160 mm(6.3") x 475 mm(18.7")
Cycle time	Raise : 5.9 sec (with load) Dump : 1.2 sec Lower : 3.0 sec (empty) Total : 10.1 sec

Brakes

Service brakes	Hydraulically actuated, wet disc brakes actuate all 4 wheels independent axle-by-axle system. Single pedal braking including clutch cut off switch.
Parking brake	Spring-applied, hydraulically released disc brake on front axle input shaft
Emergency brake	When brake oil pressure drops, indicator light alerts operator and parking brake automatically applies.

Steering system

Type	Full hydraulic power steering
Pump	Helical gear type, 110 liters/min (29.1 gal/min) @ governed rpm
Relief valve setting	210 kg/cm ² (2,990 psi)
Cylinder	Type Double acting Bore x stroke 70mm(2.8") x 436mm(17.2")
Steering angle	40°(each direction)

- Features
- Center-point frame articulation.
 - Load-sensing system.
 - Steering-wheel operated metering pump controls flow to steering cylinders.
 - Tilt and telescopic steering column.

Service refill capacities

Fuel tank	295 liters (78 USgal)
Cooling system	35 liters (9.2 USgal)
Crankcase	16 liters (4.2 USgal)
Transmission	43 liters (11.4 USgal)
Front axle	29 liters (7.7 USgal)
Rear axle	29 liters (7.7 USgal)
Hydraulic tank	130 liters (34.4 USgal)
Hydraulic system (including tank)	175 liters (46.3 USgal)

Dimensions

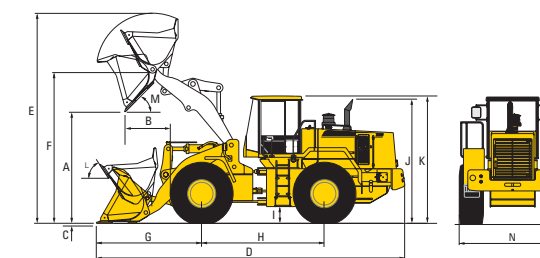

Description	UNIT	HL757-7	HL757XTD-7
Bucket Type	General purpose bolt-on cutting edge		
A. Dumping clearance at max. height and 45° dump angle.	mm (ft-in)	2,860 (9' 5")	3,270 (10' 9")
B. Reach	Full lift	mm (ft-in)	1,040 (3' 5")
	7ft height	mm (ft-in)	1,590 (5' 3")
C. Digging depth	mm (in)	95 (3.7")	130 (5.1")
D. Overall length	on ground	mm (ft-in)	7,450 (24' 7")
	at carry	mm (ft-in)	7,390 (24' 5")
E. Overall height (fully raised)	mm (ft-in)	5,250 (17' 3")	5,650 (18' 6")
F. Bucket pivot max. height	mm (ft-in)	3,910 (12' 10")	4,320 (14' 2")
G. Front overhang	mm (ft-in)	2,520 (8' 3")	2,930 (9' 7")
H. Wheelbase	mm (ft-in)	3,030 (9' 11")	3,030 (9' 11")
I. Ground clearance	mm (ft-in)	410 (1' 4")	410 (1' 4")
J. Height over exhaust	mm (ft-in)	3,130 (10' 3")	3,130 (10' 3")
K. Height over cab	mm (ft-in)	3,300 (10' 10")	3,300 (10' 10")
L. Roll-back angle	on ground	deg	41
	at carry	deg	46
M. Dump angle	deg	47	47
Clearance circle	mm (ft-in)	12,350 (40' 6")	12,720 (41' 9")
N. Overall width	mm (ft-in)	2,740 (9')	2,740 (9')

Overview

Description	UNIT	HL757-7	HL757XTD-7
Operating weight	kg (lb)	13,800 (30,420)	14,300 (31,530)
Bucket capacity	Heaped	m ³ (yd ³)	2.7 (3.5)
	Struck	m ³ (yd ³)	2.3 (3.0)
Breakout force-bucket	kg (lb)	12,720 (28,040)	12,560 (27,690)
Tipping load	Straight	kg (lb)	11,020 (24,300)
	Full turn	kg (lb)	9,510 (20,970)

Tires

Type	Tubeless, loader design tires
Standard	20.5-25, 16 PR, L3
Options include	17.5-25, 12 PR, L3 20.5-25, 16 PR, L2 20.5 R25 XHA* 20.5-25, 16 PR, L5